

# **BiSON** Birmingham Solar-Oscillations Network

TECHNICAL REPORT NO. 255

## **The Grand Opening of the Mount Wilson Zoo**

Brek A. Miller

*The University of Birmingham, Edgbaston, Birmingham B15 2TT*

2005 September 14

This technical report series is published by:



**THE UNIVERSITY  
OF BIRMINGHAM**

### **High-Resolution Optical-Spectroscopy Group**

---

School of Physics and Astronomy  
The University of Birmingham  
Edgbaston, Birmingham B15 2TT, United Kingdom  
Telephone: +44-121-414-4551 FAX: +44-121-414-1438



# The Grand Opening of the Mount Wilson Zoo

Brek A. Miller

*The University of Birmingham, Edgbaston, Birmingham B15 2TT*

2005 September 14

## Abstract

The zoo software is installed in Mount Wilson on a new computer. The front cell is changed because all of the potassium had leaked out. One of the forward detectors was replaced because it was noisy.

## 1 Introduction

I visited Mount Wilson from 2005 June 7 to June 21 in order to replace the computer and to see if I could find the cause of the decreased number of counts coming from Klaus.

Back on 2004 September 22 our Ethernet card failed. I sent a new hub to Andy Grubb on October 1 to see if it would work with our Ethernet card. Andy tried it on October 5, but it did not help. So I sent a new Ethernet card on October 7, but that did not help either. Finally, on November 2, the computer died.

In addition to the computer problems, we have also had a problem with the measured intensity from the spectrometer, which has been slowly decreasing over the last several years.

My goals for this trip were to replace the computer and to see if I could find the cause of the intensity problem.

## 2 New Zoo

The first thing that I did in Mount Wilson was put in the new computer. Andy Grubb took me on a shopping trip to Fry's Electronics to buy a monitor and a power supply. The power supply that came with our computer's case was designed to work on 240 V only. Our case was made by Antec, a well-known, multinational company that makes cases for use around the world. But now the European versions of their cases come with a different power supply. This seems to

be because there is now an EU directive that requires all European computer power supplies to have some additional power-factor-correction stuff inside. While adding this extra stuff, the manufacturers all seem to be droppings the multi-voltage capabilities.

The zoo software installation went smoothly. I even took some time trying to get the old computer working, without success. I found mouse dropping inside. I am sure the motherboard was damaged beyond all hope of repair; however, the hard disk was still working. I put it in the new computer and copied all the data files. The last day of data was 2004 November 1. The first day from the zoo is 2005 June 10. We have no data in between.

I disposed of the old computer, it was Birmingham #19. I found the old, old computer (Birmingham #12), an IBM PS/2, still in our metal crate stored in the Snow Telescope. I didn't check to see if it was still working. I did not throw it away — maybe someday we can sell it for a fortune on E-bay.

### 3 Pockels Cell

I took the spectrometer, Klaus, apart in a search for the low-counts problem. There were two false alarms before I found the actual cause. The first false alarm was the Pockels cell — most of the liquid had leaked out. This Pockels cell is Klaus's original one and was made by Hugh Williams [1].

I refilled the Pockels cell, using all of the spare liquid in the process. We'll either need to send out some more liquid or one of the Leysop Pockels cells. I had high hopes that this would cure the low-counts problem; but it did not.

### 4 Detector Oil

The second false alarm came when I removed and examined the detectors. Silicone sealant was used around the oven to keep things from rattling. The heat had caused it to outgas and there was an oily film all over the front of the detectors and collection optics. I disassembled the detectors and cleaned all of the lenses. It helped a little, but was clearly not the cause of the low-counts problem.

I failed to reassemble one of the detectors. One of the lenses got jammed sideways in the lens mount. I have brought it back to Birmingham for repair. It was one of the two aft detectors and because we are not currently using the aft cell (this will be discussed below), there is no loss of data.

## 5 Cells

The search for the low-counts problem finally led me to the cells. I removed the front cell and found that there was no visible potassium in it at all.

In total, I found four of our cells in Mount Wilson: two in Klaus and two in a cardboard box. I'll call them the forward, aft, first spare, and second spare cells. The forward cell has a short, fat stem; the aft cell has a short, skinny stem; the first spare cell had a long, fat stem; and the second spare cell has a long, skinny stem.

I first tried the first spare cell in the forward oven. However, the stem did not fit very well and great care would have been required in order to reassemble the oven without braking the stem. I did not use great care and broke the stem.

Then I tried the second spare cell in the forward oven. The stem is far too long and the potassium sticks way outside the oven. I used a couple of broken pencils to space the oven back from the magnet; but it still did not cover the potassium. I tried it like this anyway. It worked, a little, for fifty minutes. Then the counts suddenly went down again, as if there was a leak.

Finally, I tried the aft cell in the forward oven. It worked well and I left it like this. Even though the second spare cell didn't work very well, I thought I might as well put in in the aft oven; however, it didn't fit. The cube was slightly too large.

I believe that the two spare cells were actually from Mark III and are unlikely to fit in any of our modern spectrometers. I have brought all of the unused cells back to Birmingham. Later, Pere Pallé in Izaña told me that he believes the cell in Mark I also has a long stem.

One measure of how well the cell is working is the hot-to-cold ratio. Roger New reports [2] getting a hot-to-cold ratio of about 9 in 2000 May. I measured the hot-to-cold ratio for the forward cell — it was 1.25!

When I tried the second spare cell, the hot-to-cold ratio started out at about 4, but it suddenly dropped to 2 after 50 minutes. When I tried the aft cell, the hot-to-cold ratio was initially 5.3 for the starboard detector and 4.4 for the port detector. After doing some alignment scans, both hot and cold, the hot-to-cold ratios were 8.34 and 8.99.

On June 15, I cooled the cell and then did a heating curve. The two forward sums for each oven bottom set-point temperature are shown in Figure 1. The temperatures of the ovens in Klaus are controlled by Richard Lines temperature controllers. You can set the temperatures of the top and bottom separately. When I arrived, the front oven settings were  $FTOP = 545$  ( $109^\circ\text{C}$ ) and  $FOVEN = 450$  ( $90^\circ\text{C}$ ). Nominally, you need to divide the dial number by five in order to get the matching set point temperature. After looking at the data in Figure 1, I concluded that the best settings were  $FTOP = 562.5$  ( $112.5^\circ\text{C}$ ) and  $FOVEN = 462.5$  ( $92.5^\circ\text{C}$ ).

The ratios for the same heating curve are shown in Figure 2. The ratios may suggest a slightly lower temperature.

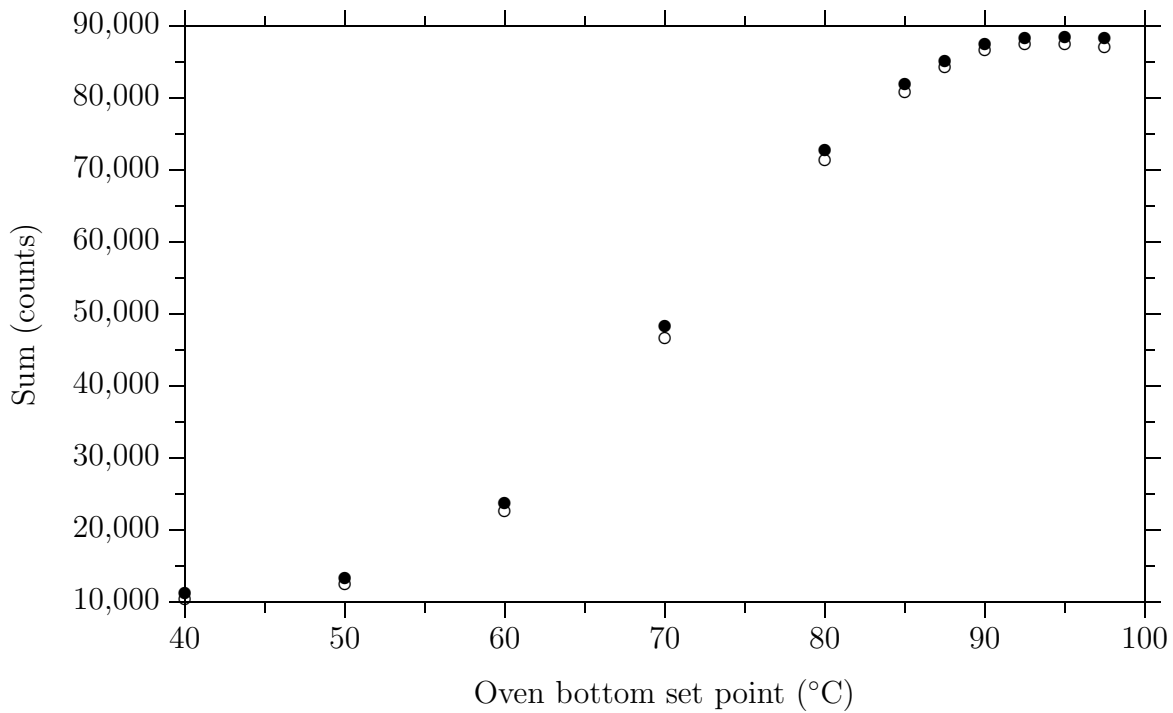

**Figure 1:** A heating curve for the aft cell in the forward oven. The forward starboard sum (●) and the forward port sum (○) are shown. This run was done on 2005 June 15.

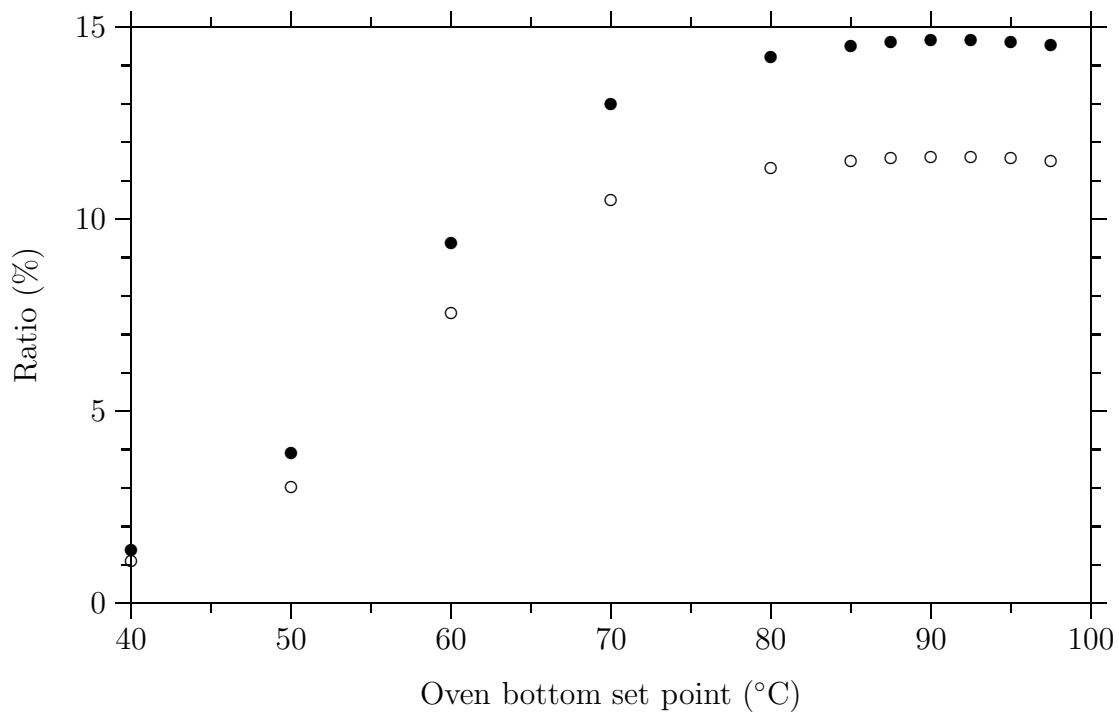

**Figure 2:** A heating curve for the aft cell in the forward oven. The forward starboard ratio (●) and the forward port ratio (○) are shown. This run was done on 2005 June 15.

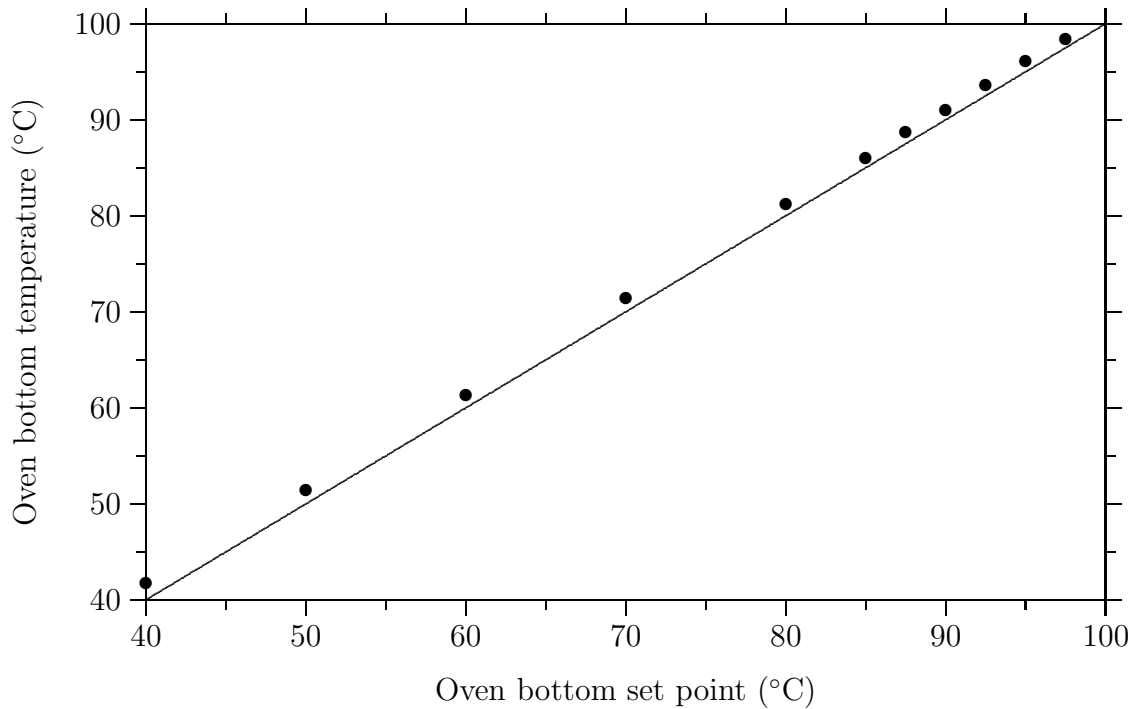

**Figure 3:** Here is how the measured oven bottom temperature compares to the temperature-controller set points. This run was done on 2005 June 15.

Figure 3 shows how the measured temperature compared to the set-point temperature for this heating curve. It isn't too bad. Richard Lines's temperature controllers do a good job.

I also tried to do a heating curve for the interference filter. When I arrived, the temperature controller setting was  $IF = 633$ . You need to divide that by 20 to get the nominal set-point temperature. I lowered the temperature by six degrees but it had no effect on either the ratios or the sums; so I couldn't do a meaningful heating curve. I just left the temperature controller set to  $IF = 633$ .

## 6 Scalers

When I first started collecting data with the new system, the beautiful data display was marred by scaler glitches. These are points that read out as all zeros and they occurred irregularly, but roughly every few minutes. I believe that these glitches have always been there; the compacting normally removes them. The old computer program used to plot points, not lines, and so a whole bunch of points at  $y = 0$  did not look too bad. The new software plots lines instead of points and the glitches look very ugly. I had to do something about it.

Initially, I focused my attention on the IBFA line from the computer to the scalars. Pulses on this line tell the scalars to send the next digit. If there is noise here, the scalars may think that the computer is asking for digits and might send them all. Then when the computer gets around to actually reading the digits, they are all gone. I put all kinds of filters and terminators all over the place; nothing worked.

After that, Clive McLeod’s automatic-buffer-reset circuitry caught my eye. In the early scaler systems by Clive, the FIFO buffer reset line is unused. The counters put digits into one side of the FIFO and the computer reads them out the other. For some reason, the scaler system in Las Campanas gets stuck a lot. I found that by connecting a wire from the computer to the FIFO reset line I could get the software to reset the FIFO every four seconds. This worked well.

After that, Clive built the Mount Wilson scaler system [3]. This time he included a small extra circuit to reset the FIFO every four seconds. I speculated that this might be randomly resetting the FIFO. Sometimes these resets would occur before the computer has had a chance to read the data and a glitch would occur.

I removed the automatic-buffer-reset circuitry and the glitches went away.

A new cable was used to connect the Clive scalers to the DIO splitter board. It is shown in Table 1.

**Table 1:** Clive Scaler Cable

Station: Mount Wilson.

Cable: 12-Conductor, 7/0.2-mm, Shielded with Black PVC Sheath.

Length: 3 m

<i>Cable Label:</i>		Counters DIO 3	Counters DIO 3	
<i>Connects to:</i>		Clive Scalers	DIO Splitter	
<i>Connects to Label:</i>		<i>none</i>	DIO 3	
<i>Connector:</i>		14-pin male IEEE-488	25-pin male D	
$\overline{D0}$	3C4	2	21	brown
$\overline{D1}$	3C5	3	22	red
$\overline{D2}$	3C6	4	23	orange
$\overline{D3}$	3C7	5	24	yellow
$\overline{MT}$	3C2	6	19	green
$\overline{EOLMSUSP}$	3A4	8	5	blue
$\overline{CHOPPER}$	3A3	9	4	violet
MODBIT	3A0	10	1	grey
$\overline{STBA}$	3C1	12	18	white
IBFA	3A1	13	2	pink
GATEBIT	3C0	14	17	cyan
gnd	gnd	1 7 11	25	black shield



## 7 Temperature Monitor

I installed the Mount Wilson Temperature Monitor on this trip. The temperature monitor is basically a 16-channel, 16-bit analog-to-digital converter. It contains some amplifiers so that it can read temperatures from four LM35 temperature-sensing ICs. The other twelve channels are configured to read pure voltages. Nine of those monitor signals from the temperature controllers; two others monitor the RA and DEC error signals from the alignment monitor.

There is no separate manual for the Mount Wilson Temperature Monitor, instead you should look at BTR-254, which is the manual for the Carnarvon Temperature Monitor. The two units are nearly identical. The only difference is in the internal wiring. The Carnarvon Temperature Monitor is internally configured for fourteen voltage channels and two LM35 channels while the Mount Wilson Temperature Monitor is configured for twelve voltage channels and four LM35 channels.

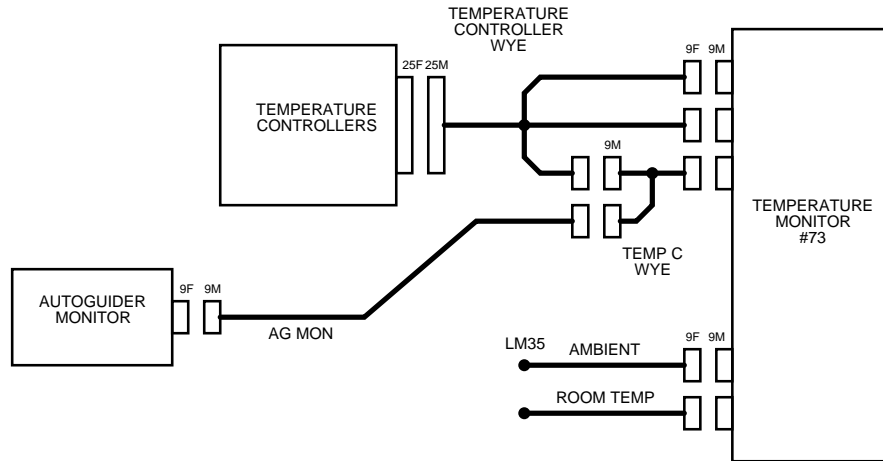

**Figure 4:** The cables used to connect the signals to the new temperature monitor.

The new cabling for the temperature monitor is shown in Figure 4. The pin assignments for these cables is shown in Tables 2 to 6. Two “wye” cables are required. The first, the *temperature controller wye*, is needed because all nine signals from the temperature controllers come out on one 25-pin D-connector. The temperature monitor puts four channels on each of its 9-pin D-connector inputs. The second, the *Temperature C Wye*, is needed because the first channel on third 9-pin D-connector on the temperature monitor is used for the interference-filter temperature while the last two channels on this connector are needed for the alignment-monitor signals.

Our policy is to make the wye cables short. Any long cable runs are done with cables with only one connector on each end. Experience has shown that where multiple long cables are soldered into one connector, “knots” form in the cables making it difficult or impossible to remove individual cables from the system — they become looped around other cables or objects.

The temperature monitor wye is small and I intended to use three long twisted-pair cables to connect the temperature controllers to the temperature monitor. But in the end, I put the

monitor right on top of the temperature controllers so the wye cable itself was long enough to reach.

The alignment-monitor signals are derived from a quadrant photodiode at the back of the spectrometer; but they are not very useful. As I found it, it was trying to take the difference between *up* and *right* to get the RA error, and the difference between *down* and *left* to get DEC error. I fixed that wiring mistake, but it didn't help very much. The circuit is all wrong. You can see the results in the next section.

## 8 Alignment Scans

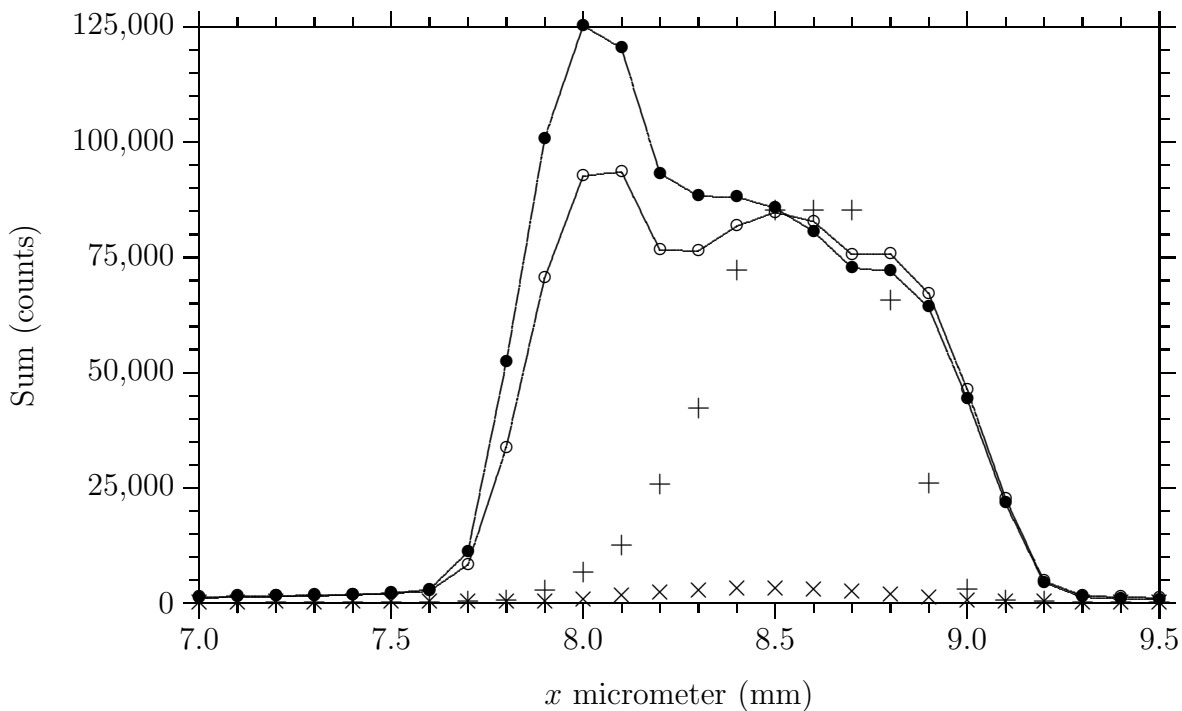

**Figure 5:** The fifth mirror was scanned in the horizontal direction. The plot shows how the forward starboard sum (●), forward port sum (○), aft starboard sum (×), and transmission monitor sum (+) varied. The transmission monitor data has been divided by ten. This scan was done with the cell hot.

There are five mirrors in the system in front of Klaus. The first two are the cœlostast mirrors. They direct the beam vertically down through the sixty-foot tower. About twenty feet from the bottom, we have added two “periscope” mirrors, oriented at 45 degrees to the vertical. They pick-off a small part of the beam. The first periscope mirror deflects the beam sideways a few feet, the second deflects it downward again.

At the bottom of the tower, the beam hits the fifth mirror and is reflected horizontally into Klaus. The final beam alignment is done with this fifth mirror. It is on an altitude/azimuth mount. Two micrometers allow it to be adjusted in the horizontal (azimuth) direction and the vertical (altitude) direction.

**Table 2:** Temperature Controller Wye

Station: Mount Wilson.

Cable: 4-pair, 7/0.2-mm, UTP, with pink PVC sheath.

Length: 100 mm

<i>Cable Label:</i>	Temps	Temp A	Temp B	Temp C	
<i>Connects to:</i>	Temperature Controllers	Temp A Cable	Temp B Cable	Temp C Cable	
<i>Connects to Label:</i>	<i>none</i>	Temp A	Temp B	Temp C	
<i>Connector:</i>	25-pin D male	9-pin D female	9-pin D female	9-pin D female	
FSTART+	10	1			blue
FSTART-	1	6			white/blue
FPORTT+	8	2			orange
FPORTT-	1	7			white/orange
FTOPT+	4	3			green
FTOPT-	1	8			white/green
FOVENT+	6	4			brown
FOVENT-	1	9			white/brown
ASTART+	18		1		blue
ASTART-	1		6		white/blue
APORTT+	16		2		orange
APORTT-	1		7		white/orange
ATOPT+	12		3		green
ATOPT-	1		8		white/green
AOVENT+	14		4		brown
AOVENT-	1		9		white/brown
IFTEMP+	2			1	blue
IFTEMP-	1			6	white/blue
				2	orange
				7	white/orange
				3	green
				8	white/green
				4	brown
				9	white/brown

**Table 3:** Autoguider Monitor Cable

Station: Mount Wilson.

Cable: 4-pair, 7/0.2-mm, UTP, with yellow PVC sheath.

Length: 10 m

<i>Cable Label:</i>	Autoguider Monitor	Autoguider Monitor	
<i>Connects to:</i>	Autoguider Monitor	Temperature C Wye	
<i>Connects to Label:</i>	<i>none</i>	Autoguider Monitor	
<i>Connector:</i>	9-pin D male	9-pin D female	
RA+	1	1	blue
RA-	5	6	white/blue
DEC+	2	2	orange
DEC-	5	7	white/orange
		3	green
		8	white/green
		4	brown
		9	white/brown

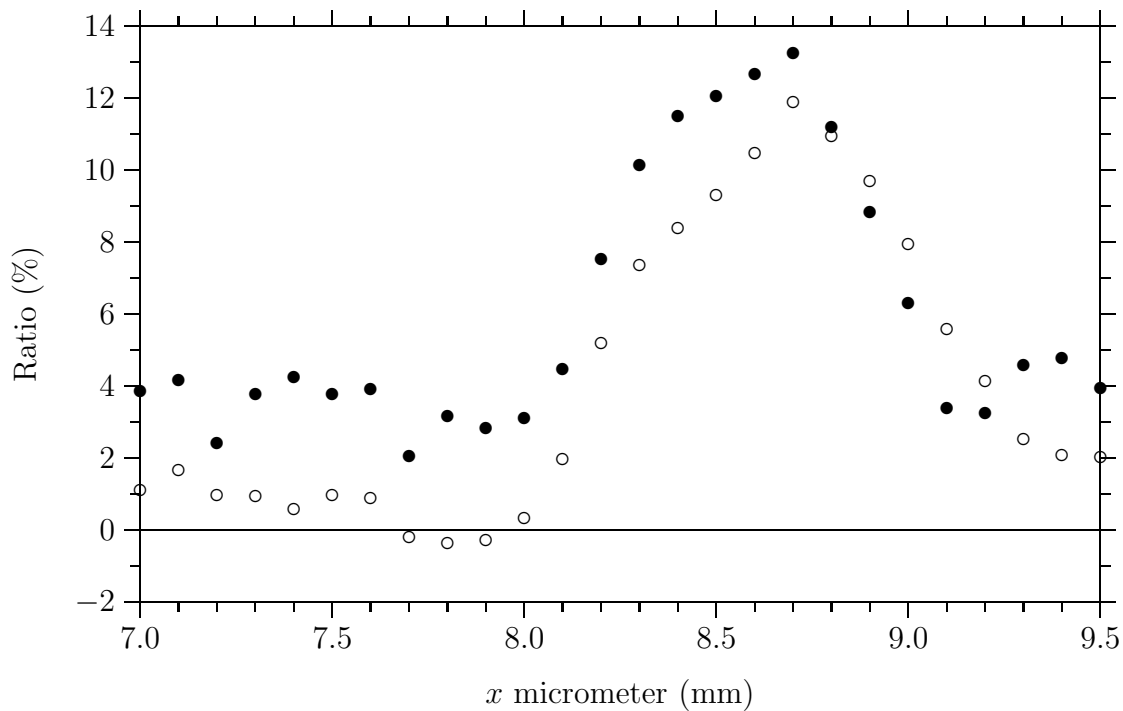

**Figure 6:** The fifth mirror was scanned in the horizontal direction. The plot shows how the forward starboard ratio (●) and forward port ratio (○) varied. This scan was done with the cell hot.

**Table 4:** Temperature C Wye

Station: Mount Wilson.

Cable: 4-pair, 7/0.2-mm, UTP, with pink PVC sheath.

Length: 100 mm

<i>Cable Label:</i>	Temp C	Autoguide Monitor	Temp C	
<i>Connects to:</i>	Temp C Cable	Autoguider Monitor Cable	Temperature Controllers	
<i>Connects to Label:</i>	Temp C	Autoguider Monitor	Temp C	
<i>Connector:</i>	9-pin D male	9-pin D male	9-pin D female	
IFTEMP+	1		1	blue
IFTEMP-	6		6	white/blue
	2		2	orange
	7		7	white/orange
RA+		1	3	blue
RA-		6	8	white/blue
DEC+		2	4	orange
DEC-		7	9	white/orange

**Table 5:** Ambient Sensor

Station: Mount Wilson.

Cable: 4-pair, 7/0.2-mm, UTP, with yellow PVC sheath.

Length: 10 m

<i>Cable Label:</i>	Ambient	Ambient	
<i>Connects to:</i>	Ambient LM35 Sensor	Temperature Monitor	
<i>Connects to Label:</i>	Ambient	Ambient	
<i>Connector:</i>	LM35*	9-pin D female	
LM35 PWR+	1	1	blue
LM35 PWR-	3	6	white/blue
LM35 SIG+	2	2	orange
LM35 SIG-	3	7	white/orange
		3	green
		8	white/green
		4	brown
		9	white/brown

\*If you look at an LM35 with the label (flat side) facing you and the pins down, the pins are, from left to right:  $+V_s$ ,  $V_{out}$ , and ground. We call these pins 1, 2, and 3 respectively.

**Table 6:** Room Temperature Sensor

Station: Mount Wilson.

Cable: 4-pair, 7/0.2-mm, UTP, with yellow PVC sheath.

Length: 10 m

<i>Cable Label:</i>	Room	Room	
<i>Connects to:</i>	Room LM35 Sensor	Temperature Monitor	
<i>Connects to Label:</i>	Room	Room	
<i>Connector:</i>	LM35*	9-pin D female	
LM35 PWR+	1	1	blue
LM35 PWR-	3	6	white/blue
LM35 SIG+	2	2	orange
LM35 SIG-	3	7	white/orange
		3	green
		8	white/green
		4	brown
		9	white/brown

\*If you look at an LM35 with the label (flat side) facing you and the pins down, the pins are, from left to right:  $+V_s$ ,  $V_{out}$ , and ground. We call these pins 1, 2, and 3 respectively.

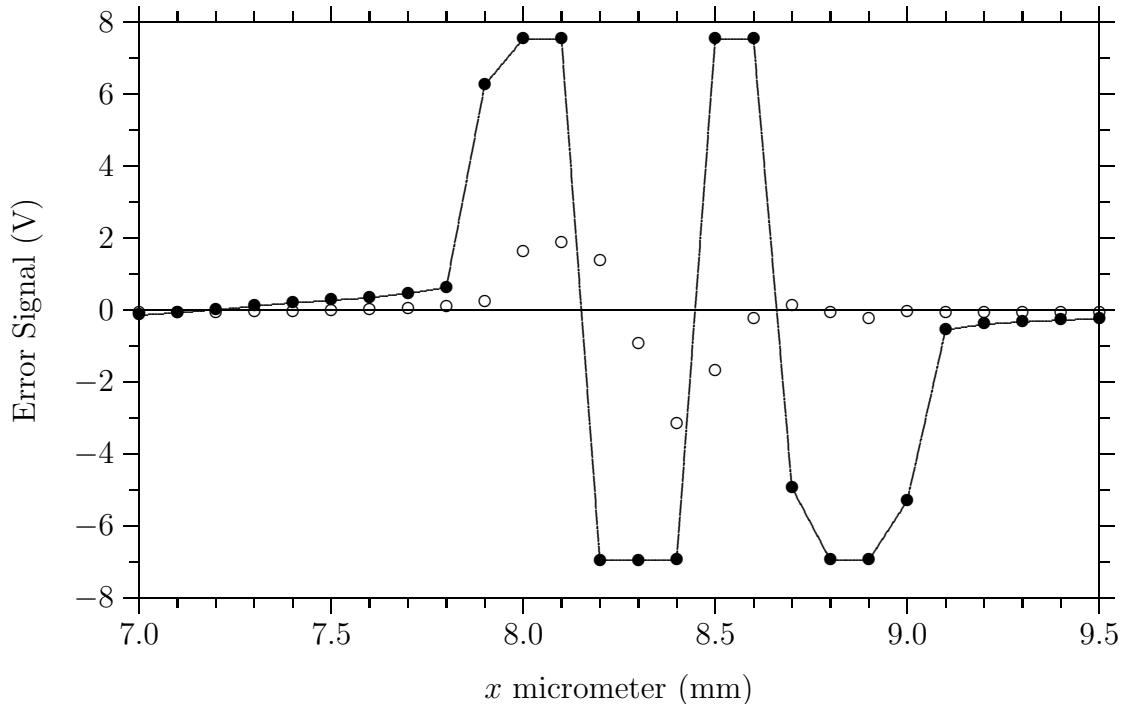

**Figure 7:** The fifth mirror was scanned in the horizontal direction. The plot shows how the right-ascension (●) and declination (○) varied.

Because of the orientation of the tower, horizontal movement of the fifth mirror corresponds to right ascension and vertical movement corresponds to declination.

There is a quadrant photodiode at the back of Klaus. It was intended that this be used as an alignment monitor. While aligning the spectrometer, I performed several scans where I moved the fifth mirror in the horizontal and vertical directions and recorded the ratios, sums, and alignment-monitor voltages. The alignment monitor outputs two signals: RA error and DEC error.

The results of one of the scans in the horizontal direction is shown in Figures 5, 6, and 7. The sums are the most useful signals to look at; they are shown in Figure 5. Only the forward detectors were working properly. There was no aft cell so there wasn't much of a signal from the aft starboard detector. The aft port detector was missing. The transmitted sum is also shown, though its signal saturates when the beam is centered in the spectrometer. After examining the forward sums on this plot, I concluded that  $x = 8.50$  mm was the correct position for the mirror. The transmission monitor is not quite in the center of the beam.

The ratios in Figure 6 concur with  $x = 8.50$  mm being the correct horizontal alignment.

The alignment-monitor signals shown in Figure 7 don't look very good. After the first few scans that I performed, I found that the alignment monitor just plain didn't work. Tracing the wires, I discovered that it was trying to get the RA error by subtracting the right quadrant from the up quadrant and the DEC error by subtracting the left quadrant from the down quadrant. That was never going to work. I fixed the wiring, but the results are still as shown in Figure 7.



When the beam is in the center, the RA error is near zero. When you increase the micrometer setting, the RA error signal increases and saturates quite quickly. This is normal for a quadrant photodiode with an occulting disc in front of it. However, if you continue to increase the micrometer setting, the RA error signal eventually starts to decrease, then goes through zero and starts to go negative, then saturates in the negative direction. This is bad. A real autoguider would not be able to work with error signals that behave like this.

After taking the alignment monitor module out and drawing the circuit, I felt pretty sure it was just wrong. It doesn't handle photodiode signals properly.

As long as the alignment is close though, the monitor works somewhat. Making fine adjustments with the micrometer I could get the RA error signal to zero at  $x = 8.38$  mm. So I believe that it is possible to use the alignment monitor to align Klaus. You need to get the alignment close, then adjust the micrometers until the alignment monitor shows that the beam is centered, then you need to increase the horizontal micrometer by 0.12 mm.

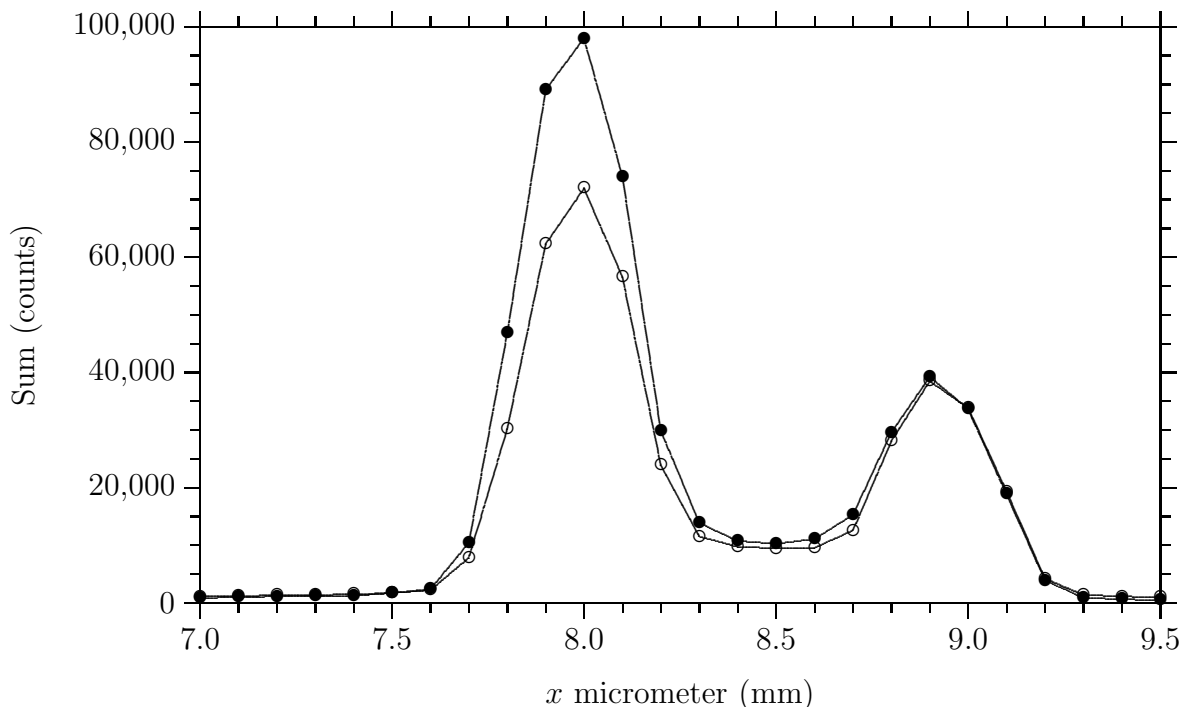

**Figure 8:** The fifth mirror was scanned in the horizontal direction. The plot shows how the forward starboard sum ( $\bullet$ ) and the forward port sum ( $\circ$ ) varied. This scan was done with the cell cold.

I also did a horizontal alignment scan with the cell cold. The only interesting data from this scan are the plots of the two forward sums; they are shown in Figure 8. From this it is obvious that  $x = 8.50$  mm is the correct setting — the cold scattering is minimized. The number of counts goes up dramatically as the beam is moved to one side or the other.

## 9 Detector Noise

On June 15 I had some time to just sit and watch the spectrometer collect data. It became obvious that the two traces, ratio and sum, from the port detector were noticeable noisier than

those from the starboard detector. After swapping cables around at various points in the system between the detectors and the counters, I was able to prove that the noise originated from within the detector.

The most sensitive part of the detector circuit is the voltage-to-frequency converter stage. The detectors in Klaus were built by Richard Lines and share the same circuit as the Narrabri detectors, which are described in BTR-47. The voltage-to-frequency converter stage is based around an OPA2111 dual op-amp from Burr Brown. I replaced the OPA2111 with a new one that I brought with me. It helped a little.

I would have liked to replace the photodiode, but I didn't have a new one with me. So I brought the detector back to Birmingham and moved the aft port detector into the forward port position. The signal from this detector was much cleaner. This swap wasn't as easy as it should have been. First of all, three of the four detectors have male LEMO connectors while the fourth (forward port) has a female connector. The power and temperature stuff go through the LEMO connectors. The signals go through BNCs, and they are all the same.

So you might expect that I would just stretch the aft port wires to the forward port position, but they didn't reach. Here's what I had to do. I connected what is now the forward port detector to the forward starboard cables. Then I connected the forward starboard detector to the aft port cables. The aft starboard detector is still plugged into the aft starboard cables. So right now the labels on the temperature monitor channels and the temperature controllers are all wrong. But at least things are working.

## References

- [1] STEVEN HALE, HUGH K. WILLIAMS, AND BREK A. MILLER. BiSON Pockels-cell list. *BISON Technical Report Series*, Number 238, High-Resolution Optical-Spectroscopy Group, Birmingham, United Kingdom, November 2004.
- [2] ROGER NEW. Work carried out at Mount Wilson 26<sup>th</sup> May to 5<sup>th</sup> June 2000. *BISON Technical Report Series*, Number 153, High-Resolution Optical-Spectroscopy Group, Birmingham, United Kingdom, October 2000.
- [3] CLIVE P. MCLEOD. BiSON scaler/control crate notes—Mount Wilson installation 1996. *BISON Technical Report Series*, Number 173, High-Resolution Optical-Spectroscopy Group, Birmingham, United Kingdom, June 2001.
- [4] IAN BARNES, BARRY JACKSON, SUKHPAL S. "PAUL" JAGPAL, AND BREK A. MILLER. The Carnarvon Temperature Monitor. *BISON Technical Report Series*, Number 254, High-Resolution Optical-Spectroscopy Group, Birmingham, United Kingdom, September 2005.
- [5] RICHARD LINES AND BREK A. MILLER. Scattered-light detector manual. *BISON Technical Report Series*, Number 47, High-Resolution Optical-Spectroscopy Group, Birmingham, United Kingdom, February 1996.